

## AD 1000 iQ

Fume Extraction System

## User Manual

Installation, Operation, and Service Information



This manual contains specific precautions related to worker safety. The hazard alert image denotes safety related instructions and warnings in this manual. DO NOT install, operate, or perform maintenance on this system until you have read and understood the instructions, precautions and warnings contained within this manual.

## Donaldson BOFA Technical Service

If a problem arises with your system, please refer to the troubleshooting section of this manual. If the problem is still not resolved, please:

- Visit our website at [donaldsonbofa.com](http://donaldsonbofa.com) for online help.
- Or contact the helpline:
  - ROW: +44 (0) 1202 699 444 (Mon-Fri 9am-5pm GMT)
  - US: +1 (618) 205 5007 (Mon-Fri 9am-5pm CST).
- Email:
  - ROW: [bofatechnical@donaldson.com](mailto:bofatechnical@donaldson.com)
  - US: [bofatechnicalus@donaldson.com](mailto:bofatechnicalus@donaldson.com)

## Serial Number

For future reference, fill in your system details in the space provided. The serial number is on the rating label located on the side/rear of the system.



## Table of Contents

<b>1</b>	<b>Overview.....</b>	<b>5</b>
1.1.	Front view of AD 1000 iQ	5
1.2.	Rear view of AD 1000 iQ	6
1.3.	Overview of control panel	7
<b>2</b>	<b>Safety information .....</b>	<b>8</b>
2.1.	Important safety notes	8
2.2.	Warning and information labels	9
2.3.	Fire risk warning	10
<b>3</b>	<b>Before installation .....</b>	<b>11</b>
3.1.	Packaging removal and system placement	11
<b>4</b>	<b>Installation .....</b>	<b>13</b>
4.1.	Fume capture methods	13
4.2.	General guidelines for a successful installation	13
4.3.	Flexible arm and nozzle extraction	13
4.4.	Moving products	13
4.5.	Enclosures	13
4.6.	Cabinets	14
4.7.	Connection to extraction system	14
4.8.	Exhausting filtered air outside	14
4.9.	Connection to power supply	14
4.10.	Optional added features	15
4.10.1.	Remote stop/start signal (optional)	15
4.10.2.	DC voltage input (optional)	15
4.10.3.	Volt-free input (optional)	15
4.10.4.	Override (optional)	16
4.10.5.	System OK signal (optional)	16
4.10.6.	Compressor (optional)	17
4.10.7.	Door interlock (optional)	17
4.10.8.	Pre-filter interlock (optional)	17
<b>5</b>	<b>Operation .....</b>	<b>18</b>
5.1.	Turning extraction system on	18
5.2.	Changing the display systems	18
5.3.	Setting the desired airflow	19
5.3.1.	To set the airflow	19
5.3.2.	Airflow auto adjust (first installation only)	19
<b>6</b>	<b>Maintenance .....</b>	<b>20</b>
6.1.	Maintenance UK	20
6.1.1.	Maintenance general	20
6.1.2.	Cleaning the extraction system	20
6.2.	Replacing filters	20
6.2.1.	75% filter blocked indication	20
6.2.2.	Pre-filter replacement	21
6.2.3.	Combined filter replacement	21

<b>7</b>	<b>Intelligent Operating System (iQ) display .....</b>	<b>23</b>
7.1.	Visual alarms on the iQ system	23
7.1.1.	Over temperature alarm	23
7.1.2.	Heat detection shut-off	23
7.1.3.	Hose blocked alarm	23
7.1.4.	Gas filter monitoring - VOC sensor (optional)	24
7.1.5.	Laser cooling filter blocked (optional)	24
7.1.6.	Door open alarm (optional)	24
7.1.7.	Run safe feature	24
7.2.	USB connectivity	25
7.2.1.	Event log	26
<b>8</b>	<b>Troubleshooting.....</b>	<b>28</b>
8.1.	Fault indication	28
8.1.1.	Blower failure detection	28
8.1.2.	Internal power supply	28
8.1.3.	Error codes on the iQ display	28
8.1.4.	USB diagnosis	28
<b>9</b>	<b>Replacement parts.....</b>	<b>29</b>
9.1.	Consumable spares	29
9.2.	Maintenance protocol	29
9.3.	Filter disposal	29
<b>10</b>	<b>System specifications .....</b>	<b>30</b>
<b>11</b>	<b>Contact information.....</b>	<b>31</b>
<b>12</b>	<b>Inspection record.....</b>	<b>32</b>

# 1 Overview

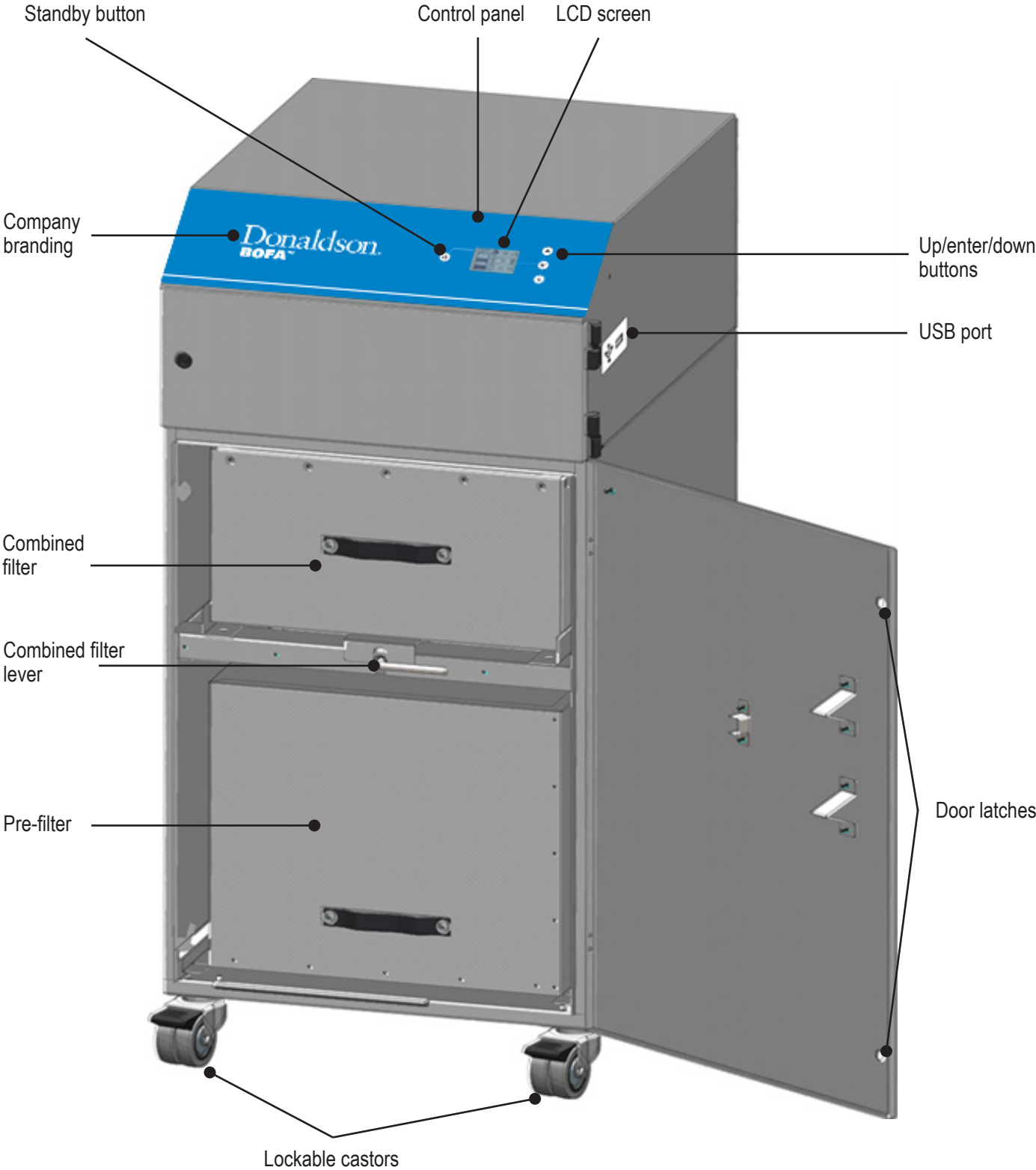
## 1.1 Front view of AD 1000 iQ



1.2. Rear view of AD 1000 iQ

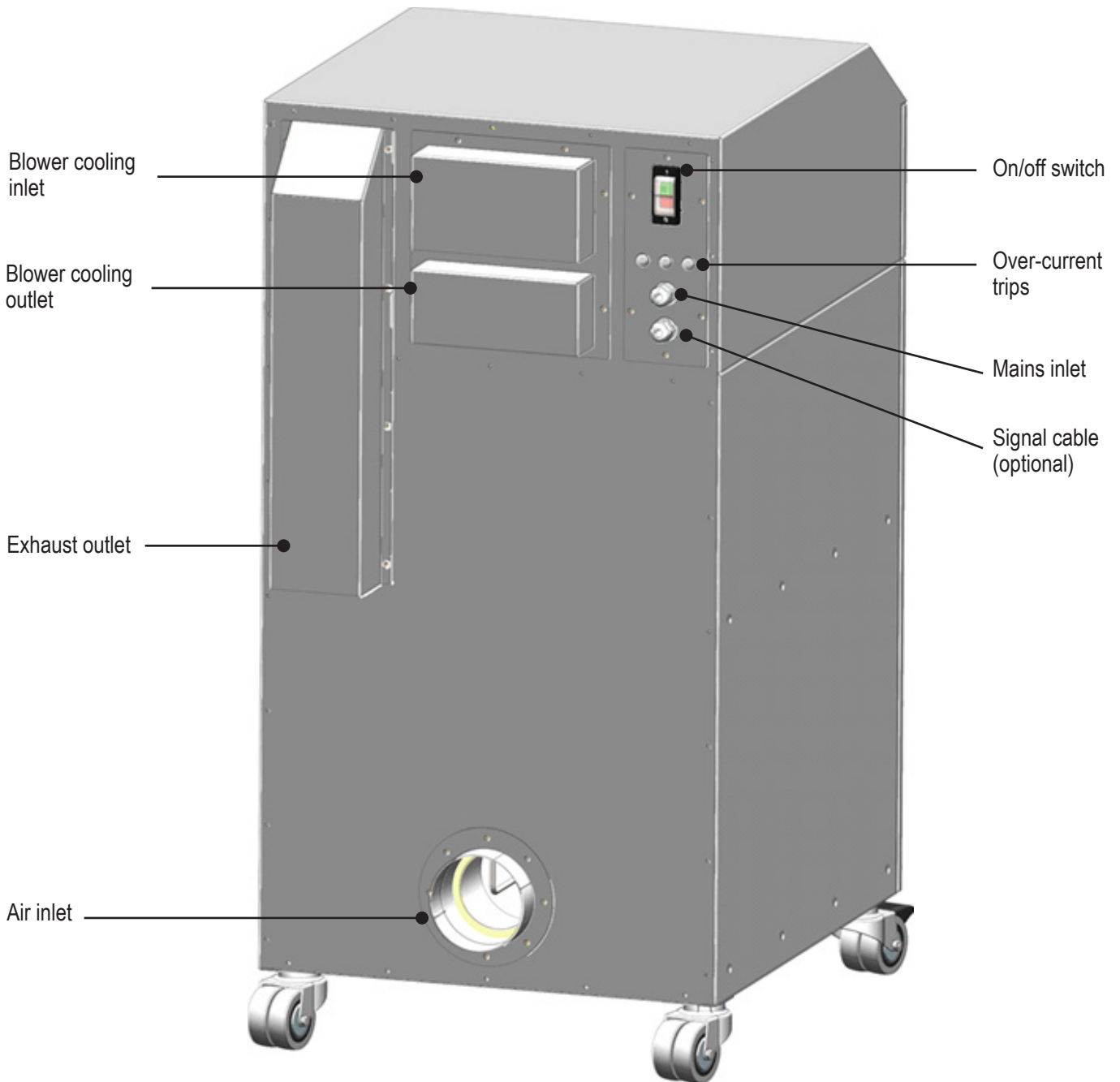

### 1.3. Overview of control panel



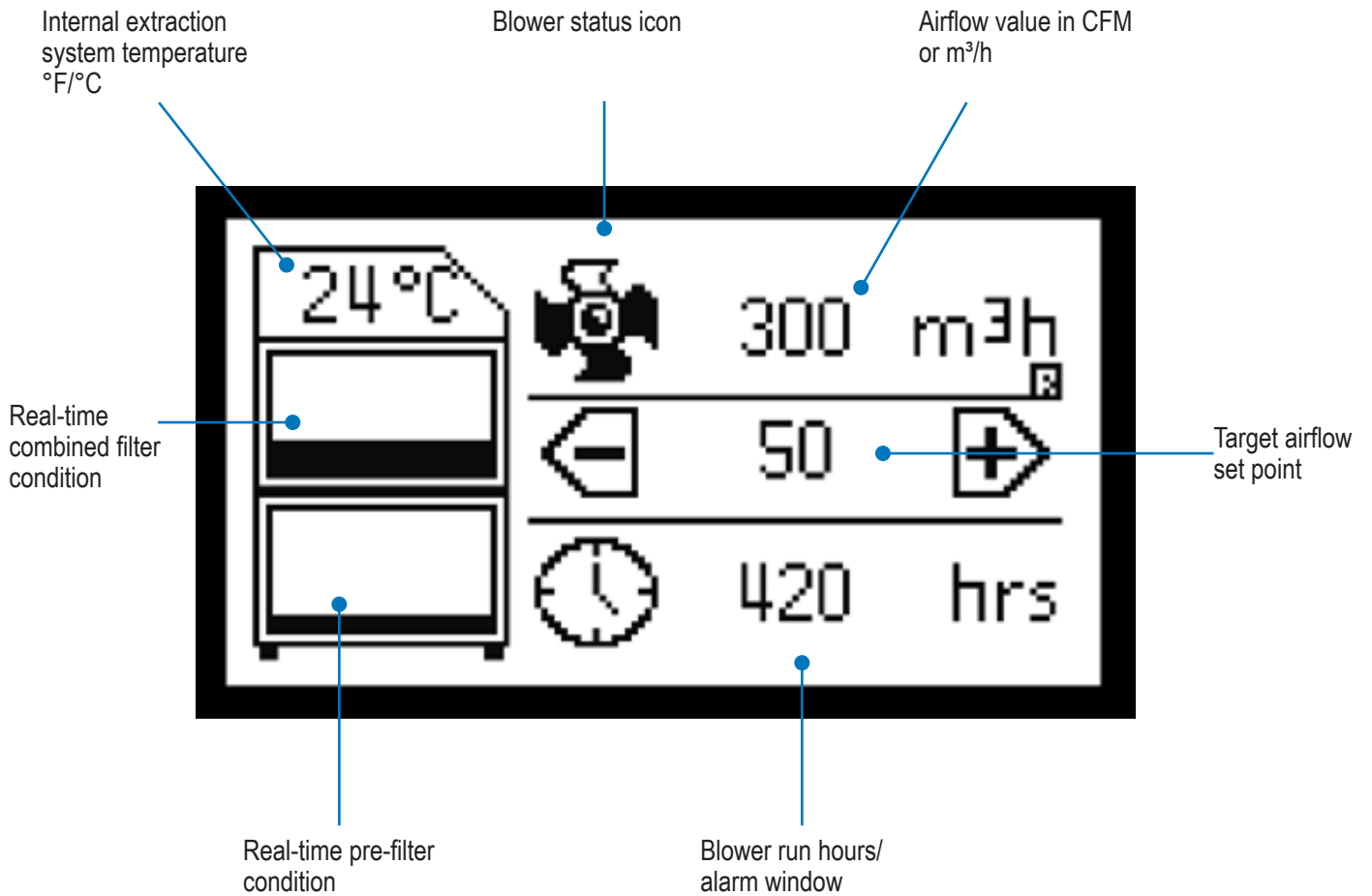

The diagram below shows an overview of LCD features.



## 2 Safety information

### 2.1 Important safety notes

Concerning symbols used on the extraction system and referred to within this manual.

Symbol	Meaning	
	DANGER	Refers to an immediately impending danger. If the danger is not avoided, it could result in death or severe (crippling) injury. Please consult the manual when this symbol is displayed.
	WARNING	Refers to a possibly dangerous situation. If not avoided, it could result in death or severe injury. Please consult the manual when this symbol is displayed.
	CAUTION	Refers to a possibly harmful situation. If not avoided, damage could be caused to the product or something in its environment.
	IMPORTANT (refer to manual)	Refers to handling tip and other particularly useful information. This does not signify a dangerous or harmful situation. Refer to manual when this symbol is displayed.

### EU Declaration

The system has been designed to meet the essential health and safety requirements of the Machinery Directive 2006/42/EC, Low Voltage Directive 2014/35/EC, and the EMC Directive 2014/30/EU. For the full DOC and further information please contact the technical team:

- US: [bofatechnicalus@donaldson.com](mailto:bofatechnicalus@donaldson.com)
- ROW: [bofatechnical@donaldson.com](mailto:bofatechnical@donaldson.com)

### Electrical safety

The system has been designed to meet the essential health and safety requirements of the Low Voltage Directive 2014/35/EC. The requirements of the EMC Directive 2014/30/EU are also met.

### Warning

When working with the blower housing open, live 230/115 volt mains components are accessible. Ensure that the rules and regulations for work on live components are always observed.

### Important

To reduce the risk of fire, electric shock, or injury:

1. Always isolate the system from the mains power supply before removing the blower access panel.
2. Use only as described in this manual.
3. Connect the system to a properly grounded outlet.

## Dangers to eyes, breathing, and skin

Once used, the filters within the extraction system may contain a mixture of particulates, some of which may be sub-micron size. When the used filters are moved, it may agitate some of this particulate, which could get into the breathing zone and eyes of the operative.

Additionally, depending on the materials being processed, the particulate may be an irritant to the skin.

**This system should not be used on processes with sparks of flammable materials or with explosive dusts and gases, without implementation of additional precautions.**

	CAUTION	When changing used filters, always wear a mask, safety shoes, goggles, and gloves.
-----------------------------------------------------------------------------------	---------	------------------------------------------------------------------------------------

## Carbon selection





Please note that the media within the gas filter fitted in the extraction system is capable of adsorbing a wide range of organic compounds. However, it is the responsibility of the user to ensure it is suitable for the particular application it is being used on.

## Intended use

This equipment has been designed to extract and filter fume from a variety of applications. However, it is the user's responsibility to ensure the equipment is installed correctly and is suitable for the application. This extraction system must not be used on wet applications or acidic fumes.

## 2.2. Warning and information labels

The following listing details labels used on your system.

Symbol	Meaning	
	GOGGLES, GLOVES AND MASK	This appears on filters, indicating that goggles, gloves, and masks should be worn while handling used filters.
	DO NOT COVER	Do not cover any louvers or holes on panels adjacent to the label.
	ELECTRICAL DANGER	Removal of panels with this label attached will allow access to potentially live components.
	WARNING	Power should be isolated before the panel with this label attached is opened/removed.

**PLEASE NOTE:** If the equipment is used in a manner not specified by the manufacturer, the protection provided by the equipment may be compromised.

### 2.3. Fire risk warning

In the very rare event that a burning ember or spark is drawn into the fume extraction system, it may be possible that the filters will ignite. Whilst any resultant fire would typically be retained within the fume extraction system, the damage to the extraction system could be significant.

It is therefore essential to minimize the possibility of this occurring by undertaking an appropriate risk assessment to determine:

- a). Whether additional fire protection equipment should be installed.
- b). Appropriate maintenance procedures to prevent the risk of build-up of debris which could potentially combust.

This extraction system should not be used on processes where sparks could occur, with explosive dusts and gases, or with particulates that can be pyrophoric (can spontaneously ignite), without implementation of additional precautions. It is essential that nozzles or other extraction/fume capture devices and hoses/pipework are cleaned regularly to prevent the build-up of potentially ignitable debris.

### 3 Before installation

#### 3.1 Packaging removal and system placement

Before installation, check the extraction system for damage.

All packaging must be removed before the system is connected to the power supply.

**Please read all instructions in this manual before using this extraction system.**

1. Move the system to the location where it is going to be installed and remove the outer packaging.  
**This system should be installed in a well-ventilated area.**
2. Open the front door and remove the transit foam and straps from system. Ensure that 20" (500 mm) space is available around any vented panels on the system to ensure adequate airflow.
3. With the system in position, lock the two front castors.

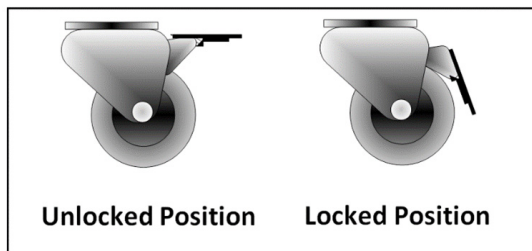

	<b>CAUTION</b>	Due to the weight of the extraction system, suitable lifting equipment should be used and appropriate safety precautions taken (see system specification section for product weight detail).
--	----------------	----------------------------------------------------------------------------------------------------------------------------------------------------------------------------------------------

	<b>CAUTION</b>	Do not block or cover the cooling vents on the extraction system as this severely restricts airflow and may cause damage to the system.
--	----------------	-----------------------------------------------------------------------------------------------------------------------------------------

	<b>CAUTION</b>	Under no circumstances should the exhaust outlet/s be covered as this will restrict the airflow and cause overheating.
--	----------------	------------------------------------------------------------------------------------------------------------------------

4. Check the filters are located in their correct position before closing the door and securing the door latches.

**Note:** The door will not close fully if the combined filter has not been secured in place using the internal lever (as detailed below).



## 4 Installation

The system has been designed to remove and filter fume containing potentially hazardous particulate and gases generated during manufacturing processes. Such hazardous substances are captured within a multi-stage filtration system after which the cleaned air is returned to the workplace.

### 4.1. Fume capture methods

The fume is normally captured by 1 of 3 methods.

- Flexible arm/nozzle
- Enclosures
- Cabinets

### 4.2. General guidelines for a successful installation

Laser marking/coding used as an example in the following sections and images.

- Keep duct run length to a minimum.
- Avoid sharp bends/turns in the ductwork.
- Avoid multiple bends/turns in the ductwork.
- Use a larger diameter duct where able.
- Position the capture device as close as possible to the marking point (if used on high-speed lines, position the capture device slightly downstream).

### 4.3. Flexible arm and nozzle extraction

- Stay put arm should be mounted as close as possible to the marking point using the clips provided.
- Unscrew the push-fit connector from the other side of the flexible hose.
- Cut the flexible hose to suit the distance back to the extraction system connection and push onto the system inlet.

Purge air should be kept to a minimum, where possible, to prevent the fume being blown away from the nozzle. High-speed lines may need bigger scoops or nozzles both sides of the product because of the turbulence caused by the speed of the product (e.g., bottling lines).

### 4.4. Moving products

For applications where the product is moving past the stationary marking point head, the capture nozzle should be positioned as close as possible to the marking area on the side the product is moving towards.

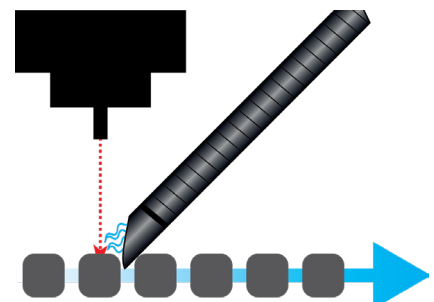

### 4.5. Enclosures

The extraction hose and nozzle can be attached to the enclosure surrounding the marking zone provided that the extraction point is within 1.96"-2.95" (50-75 mm) of the marking point.

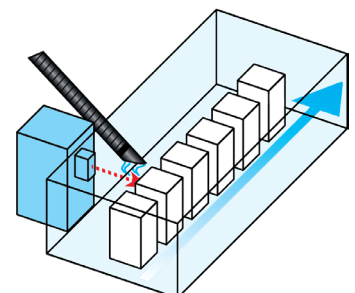

**4.6. Cabinets**

Cabinets normally have a 2.95” (75 mm) or 3.93” (100 mm) spigot for fume extraction. For best performance, use the same diameter hose as the spigot and reduce at the extraction system end if necessary. **Keep the hose run as short as possible.**

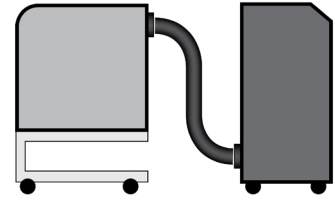

**4.7. Connection to extraction system**

All ductwork should be installed and connected to the extraction system before it is turned on.

**4.8. Exhausting filtered air outside**

If requested, your system will have been fitted with an exhaust outlet spigot. This provides a connection point for exhaust pipework to be fitted. It is important to keep any ducting to a minimum to reduce back pressure within the system.

**4.9. Connection to power supply**

Please follow the specification at the rear of the manual when selecting the power supply outlet for the system. Ensure the power supply is suitable before connecting the system.

	<p><b>ELECTRICAL DANGER</b></p>	<p>Check the integrity of the electrical power cable. If the supply cord is damaged, the extraction system should not be connected to the mains. The supply cord should only be replaced by a Donaldson BOFA engineer as an electrical safety test may be required after replacement.</p>
	<p><b>CAUTION</b></p>	<p>The system <b>MUST</b> be connected to a properly earthed outlet.</p>

**Important - 3 phase systems only: It is very important to ensure that the neutral connection is connected before turning the system on. Failure to do this may result in damage to the extraction system.**

If your system was customized for your order, please read the optional features section before the power connection is made as additional connections may be required before power is connected to the extraction system.

Connect the power cable to an isolated electrical supply.

The mains socket should be installed near the extraction system. It should be easily accessible and able to be switched on/off. The cable run must be arranged to prevent trip hazard.

This equipment shall be mounted in accordance with local regulations.

**Portable appliance testing guidance**

This appliance is a Class I electrical product that requires earth protection. The appliance contains Type 3 SPDs (surge protection devices). During PAT Testing, test voltage L-E and N-E must be limited to 250 VDC to avoid engaging the surge protection.

#### 4.10. Optional added features

The system can be configured to suit customer specification. These optional features would be discussed, arranged, and installed prior to delivery.

**If unsure what features your system is equipped with, please contact the seller with the extraction system serial number (refer to section 2 for location), who will be able to advise what specification has been supplied.**

For other custom filter signal configurations (details of connectors and pin-outs), these will be included in an appendix at the rear of the manual.

##### 4.10.1. Remote stop/start signal (optional)

Enables the extraction system to be remotely turned on/off via an external signal. This feature can be configured in 3 ways:

- DC voltage input – range 12-24 VDC
- Volt-free input – open/closed contacts
- Override – stop/start feature switched off

**Note: Care must be taken to ensure that the system is correctly wired in order for the extraction system to function correctly.**

##### 4.10.2. DC voltage input (optional)

This configuration requires the black and red cores of the signal cable (refer to section 1 for location) to be connected to a known and tested DC power supply to start the extraction system.

The operating voltage for this signal is between 12 and 24 VDC. Only voltages within this range should be connected. Voltages connected outside of this range may cause irreversible damage to the internal control PCB.

**Red cable = V+**

**Black cable = V-**

When the extraction system is provided with the correct DC voltage, the blower will start and maintain the set flow rate. When the DC voltage is removed, the blower will slow down and come to a stop.

The extraction system will need to be turned on and be out of standby mode in order for this feature to operate.

##### 4.10.3. Volt-free input (optional)

This configuration requires the black and red cores of the signal cable (see section 1 for location) to be connected together in order to start the extraction system.

When the two cables are connected together, the blower will start and maintain the set flow rate. When the two cables are disconnected, the blower will slow down and come to a stop.

The extraction system will need to be turned on and be out of standby mode for this feature to operate.

#### 4.10.4. Override (optional)

Enables the extraction system to operate fully with or without either DC voltage input or the volt-free input.

The override feature can be toggled on/off by a switch mounted on the internal blower access panel (see picture on the right for switch location).

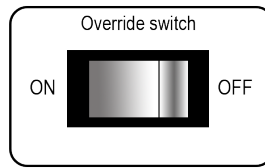

##### Switch in “on” position

In this position, the extraction system will require a start signal (either voltage input or volt-free, depending on the requested specification) to enable the blower within the system.

##### Switch in “off” position

In this position, the extraction system blower will run without the requirement for an external start signal. This feature is useful for engineers carrying out works/tests on the extraction system without the need for the host machine/auxiliary signal.

The power supply unit which is used to provide the 12-24 VDC stop/start voltage signal must be protected by double insulation from mains voltage.

#### 4.10.5. System OK signal (optional)

The extraction system will output a signal to alert the user when the system has failed or when the filters are blocked.

This feature will not directly stop the extraction system from running correctly, but if fitted, this feature should be terminated correctly before power is applied to the system.

##### Connection specification

This signal is available via the green and white cores of the signal cable. The system will provide a volt-free open/closed signal that can be connected to an external interface, beacon, or warning device following the specification below.

- **Maximum input voltage: 24 VAC**
- **Maximum current load: 3 AAC**

OR

- **Maximum input voltage: 24 VDC**
- **Maximum input load: 3 ADC**

When the filters become blocked or the system develops a fault (refer to troubleshooting section), the connection between the green and white cables will become “open”.

When the extraction system is running normally, the connection between the green and white cables will become “closed”.

#### 4.10.6. Compressor (optional)

If a compressor has been fitted to the extraction system, connect the compressor hose to the system compressor outlet (refer to section 1 for location), and connect the opposite end to the host machine (refer to host machine installation instructions). A water trap should be fitted to the host machine end of the pipework.

#### 4.10.7. Door interlock (optional)

When fitted with a door interlock, the iQ system will not function if the front door has been left open. There is a switch located on the top internal panel. To enable the system to function, the front door must be closed, and the latches secured.

#### 4.10.8. Pre-filter interlock (optional)

When fitted with a pre-filter interlock, a second switch will have been installed.

If there is no pre-filter fitted, the iQ system will prevent the extraction system from starting up. A pre-filter will have to be installed, and the front door closed before the system is able to start.

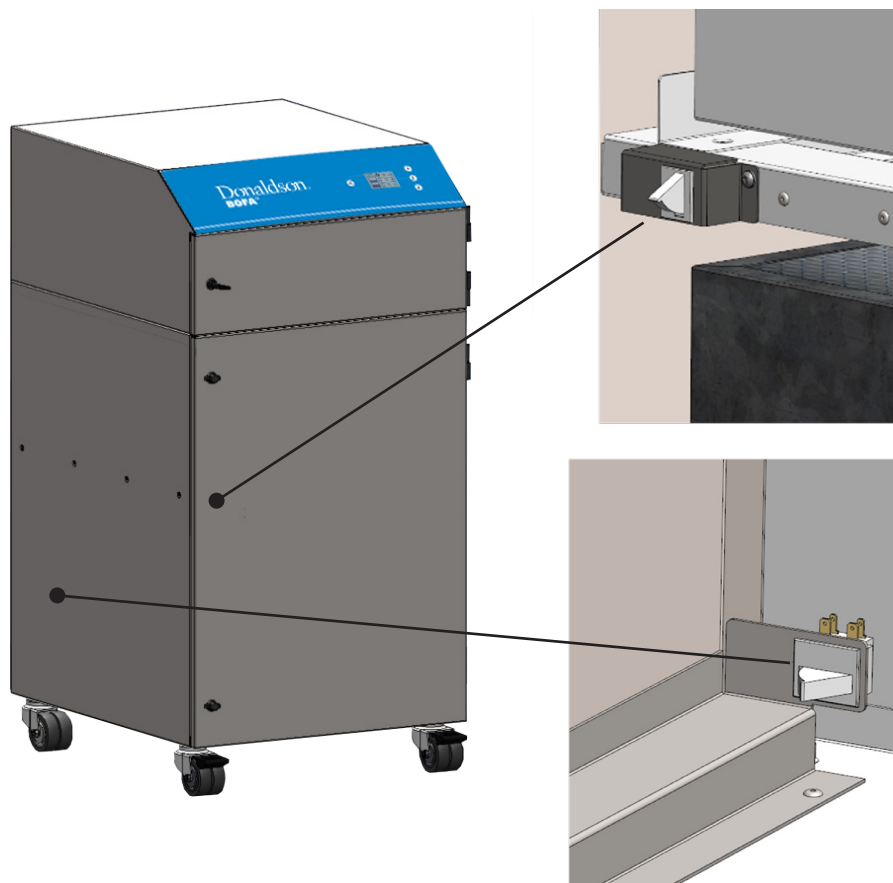

## 5 Operation

### 5.1. Turning extraction system on

There are two stages to powering up your iQ extraction system. The on/off switch must be switched to the “on” position (refer to section 1 for switch location).

This will place the extraction system in standby mode, indicated by the front panel power button illuminating red.

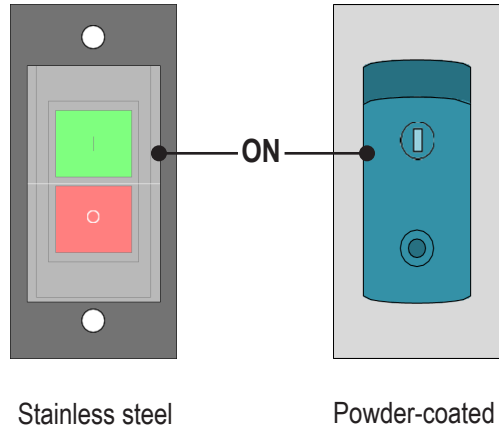

To start the system, press the front panel power button (refer to section 1 for location). The button will change from red to green, indicating the extraction system is now fully on.

It is recommended that the rear on/off switch is left in the on position and the front standby switch is used to toggle the extraction system on/off.

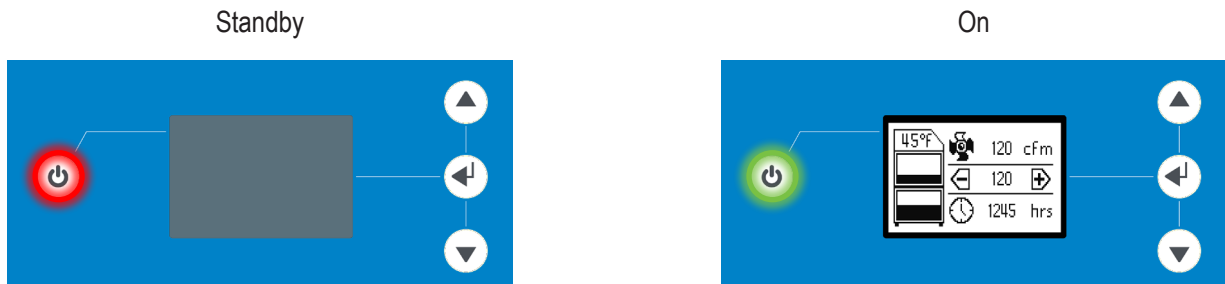

### 5.2. Changing the display systems

The airflow and temperature readings can be displayed in two ways.

1. Temperature displayed as °C - Airflow displayed as m<sup>3</sup>/h

OR

2. Temperature displayed as °F - Airflow displayed as CFM

The display value can be changed by pressing the “enter” middle button once.

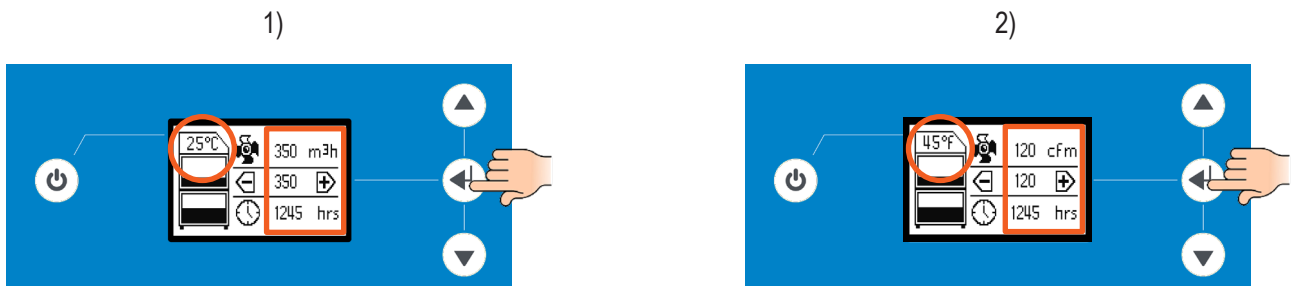

### 5.3. Setting the desired airflow

The iQ system features automatic flow control. This enables the user to set the required airflow rate, then over time, as the filters begin to block, the blower will automatically begin to increase in speed to compensate for any loss in performance caused by the added restriction of the partially blocked filters.



**IMPORTANT**  
(refer to manual)

The extraction system and all pipework must be fully installed and connected before the airflow is set.

#### 5.3.1. To set the airflow

The airflow can be set between 177-459 cfm (300-780 m<sup>3</sup>/h) at 230 V or 177-430 cfm (300-730 m<sup>3</sup>/h) at 115 V.

1. Press and hold the “enter” middle button for three seconds or until all three button lights flash green.
2. Release the “enter” button, the iQ system is now in set mode. Press either the “up” or “down” button to adjust the flow rate accordingly.
3. Real-time flow rate is displayed on the LCD screen.
4. Once you have achieved your desired flow rate, release the controls. After approximately ten seconds, the flashing buttons will remain illuminated constantly to confirm that the flow rate has been stored.

The set flow rate will now be maintained throughout the life of the filter. When the extraction system can no longer maintain the set flow rate, an alarm will sound and the display will indicate which filter should be changed.

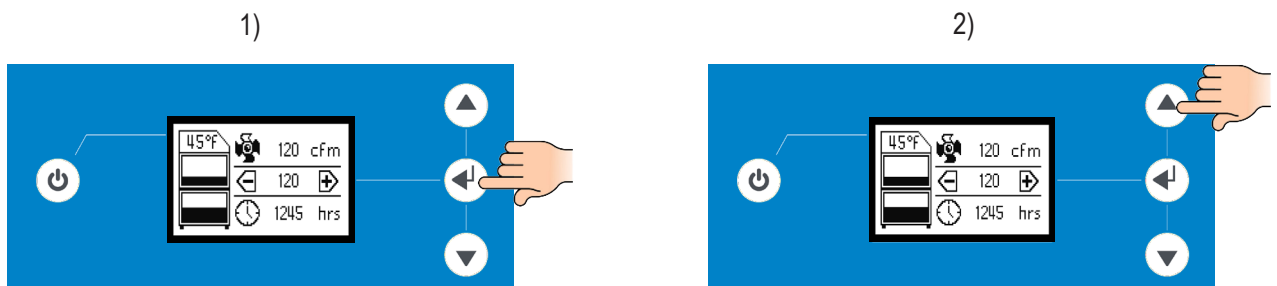

#### 5.3.2. Airflow auto adjust (first installation only)

When first setting the airflow on your new extraction system, the iQ system will detect if the desired airflow is achievable with the installation that has been connected to the system.

If the installation is causing too much restriction for the desired airflow to be reached, the auto adjust feature will be activated.

1. The three buttons will flash red along with the airflow setting on the LCD screen.
2. The airflow setting on the screen will drop to display the highest airflow that can be achieved.
3. The airflow will stabilize, and the buttons will turn green to show the airflow has set.

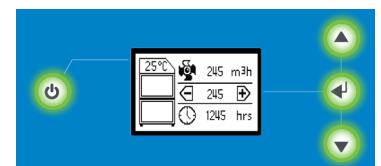
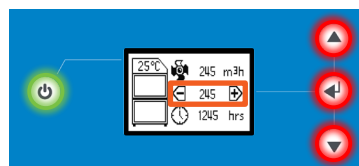
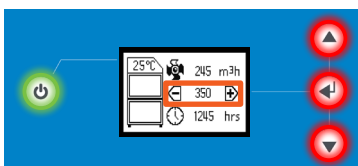

## 6 Maintenance

### 6.1 Maintenance UK

It is a legal requirement, under regulation 9 of the COSHH regulations, that all local exhaust ventilation systems are thoroughly examined and tested at least once every 14 months (typically carried out annually). The approved code of practice recommends that a visual check should be carried out at least once a week.

COSHH requires the annual inspection and testing to be carried out by a competent person and specifies that documentation results are recorded in a log.

Contact the seller for more information about inspection and certification.

#### 6.1.1 Maintenance general

User maintenance is limited to cleaning the system and filter replacement, only the manufacturers trained maintenance technicians are authorized to carry out component testing and replacement. Unauthorized work or the use of unauthorized replacement filters may result in a potentially dangerous situation and/or damage to the extraction system and will invalidate the manufacturer's warranty.

#### 6.1.2 Cleaning the extraction system

Stainless steel extraction systems should be cleaned with a non-acidic proprietary stainless steel cleaner, in accordance with the manufacturer's user instructions.

The powder-coated finish can be cleaned with a damp cloth and non-aggressive detergent, do not use an abrasive cleaning product as this will damage the finish.

The cooling inlets and outlets should be cleaned once a year to prevent build-up of dust and overheating of the extraction system.

### 6.2 Replacing filters

The iQ system constantly monitors the condition of the filter. As the filter blocks, the LCD will show the filter symbol filling up. The filter symbol fills up in 5% increments. When the filter is full, the warning icon will alert the user the filter needs replacing.

It is recommended to replace filters every 12 months, unless the system prompts for more frequent changes. Users should maintain a record of these replacements.

The filter requires attention when the display shows the filter blocked icon/filter output signal or when the extraction system no longer removes fume efficiently.

It is recommended that a spare set of filters are kept on-site to avoid prolonged extraction system unavailability. Part numbers for replacement filters can be found on the filters fitted in your system.

To prevent overheating, extraction systems should not be run with a blocked filter condition, or with dust obstruction of inlets/outlets.

#### 6.2.1 75% filter blocked indication

When the filters become 75% blocked, the buttons on the front of the extraction system will turn from green to amber, and if fitted, the iQ system will output a signal to indicate this. At this time, it is recommended spare filters are available, as a change may be needed shortly.

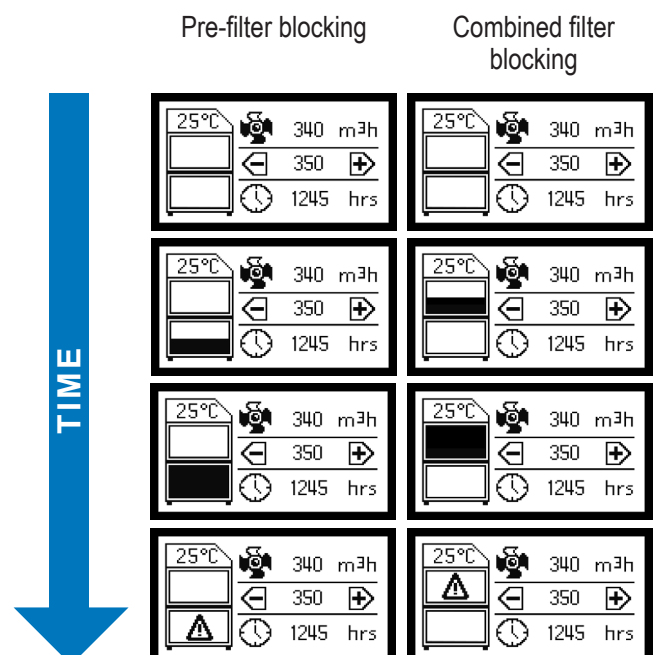

### 6.2.2. Pre-filter replacement

Refer to section 2.2 for PPE requirements.

The pre-filter needs replacing when the display flashes between the two images shown below. At this point, the buttons will illuminate red and if fitted the filter blocked signal will be given.

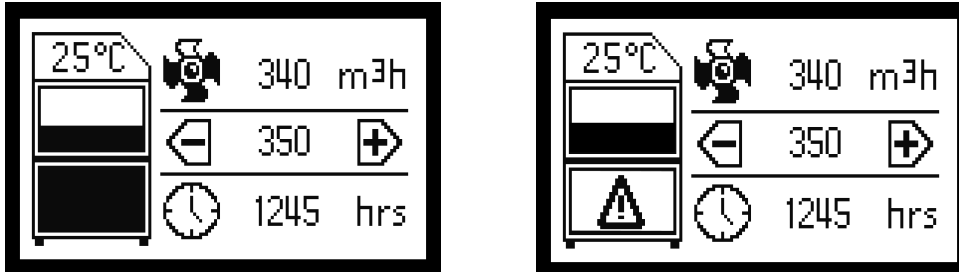

To remove and replace the pre-filter, follow the procedure detailed below.

1. Isolate the electrical supply to the extraction system.
2. Undo the latches on the front of the extraction system and open the door.
3. The pre-filter is the lower of the two filters. Using the handle on the front of the filter, pull it out of the extraction system.  
**Important: the handle must only be used for the purpose of pulling out the filter.**
4. Once removed, it is recommended that the used filters are bagged and sealed.
5. Slide in the new filter, ensuring it is fully pushed in and positioned correctly on the spigot in the back of the extraction system.
6. Close the door and fasten the two latches.

### 6.2.3. Combined filter replacement

The combined filter needs replacing when the display flashes between the two images shown below. At this point, the buttons will illuminate red, and if fitted, the filter blocked signal will be given.



#### WARNING

The combined filter is over 88.2 lbs (40 kg) therefore the procedure below must be carried out by two people lifting together.

To remove and replace the combined filter, follow the procedure detailed below.

1. Isolate the electrical supply to the extraction system.
2. Undo the latches on the front of the extraction system and open the door.
3. The combined filter is the higher of the two filters. Rotate the lever below the filter through 180° to lower the combined filter.
4. Using the handle on the front of the filter, pull it out of the system being careful to support it as it comes free as it is heavy.  
**Important: the handle must only be used for the purpose of pulling out the filter.**
5. Once removed, it is recommended that the used filters are bagged and sealed.
6. Slide in the new filter, ensuring it is fully pushed in and positioned correctly
7. Rotate the lever back through 180° to raise the filter into position.
8. Close the door and fasten the two latches.
9. Reconnect the power supply.



**Both filters MUST be fitted when the extraction system is in use, if the combined filter is not installed correctly the iQ system will not allow the blower to operate.**

## 7 Intelligent Operating System (iQ) display

### 7.1. Visual alarms on the iQ system

The iQ system can visually display a range of alarms on its LCD panel. The visual displays, meanings, and solutions are detailed below. All alarms will trigger the system alarm interface output signal and the inbuilt audible buzzer if fitted/activated. The image to the right shows some of the fault icons that may appear.

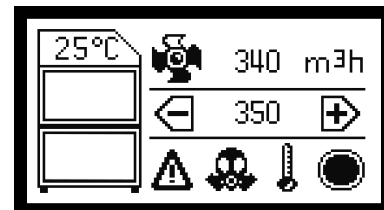

#### 7.1.1. Over temperature alarm

If the iQ system detects an internal temperature greater than 140 °F (60 °C) then it will automatically shut down the extraction system to prevent damage to components within the extraction system.

Once the internal temperature has dropped by 41 °F (5 °C), the extraction system will be able to restart. To restart the extraction system after an over-temperature alarm, the extraction system needs to be placed in standby mode then powered on again.

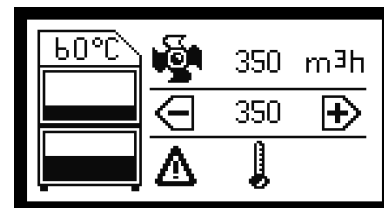

#### 7.1.2. Heat detection shut-off

The system has an internally mounted thermal trip that detects the temperature in the filter compartment. If the temperature rises above 131 °F (55 °C) then the extraction system will automatically shut down the blower and display the symbol in the image on the right.

If this symbol is displayed, the extraction system should be totally isolated from the mains supply and the extraction system should be fully inspected for evidence of the temperature rise (including inside the pre-filter).

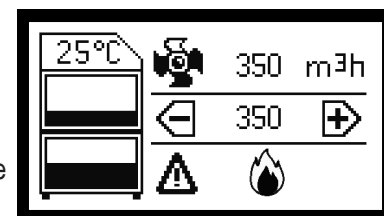

Once the system is safe to turn back on and the internal temperature has dropped below 122 °F (50°C), the thermal trip can be reset. To do this, follow the procedure below.

1. Isolate the supply from the extraction system.
2. Open the front door and remove the combined filter.
3. Locate the circular cut out in the shelf, at the front of the extraction system.
4. Inside the cut out, there is a small red button that can now be pressed back in.
5. Re-fit the combined filter, close the front door, and re-connect the mains supply.

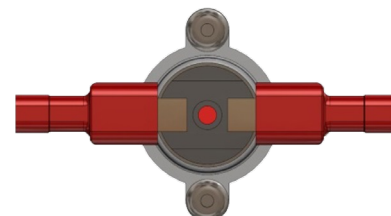

#### 7.1.3. Hose blocked alarm

The iQ system features a two-stage hose blocked alarm.

- Partial hose blockage
- Full hose blockage

##### Partial hose blockage

This alarm is triggered when the iQ system detects a partial blockage in the installation. The iQ system interprets a partial blockage as a vacuum spike within the ductwork, but is only a partial blockage as the extraction system is still able to maintain its set airflow.

During this time, it is normal to hear the blower increase in speed. The blockage will need to remain in the ductwork for over 5 seconds to trigger the alarm.



### Full hose blockage

This alarm is triggered when the iQ system detects a full blockage in the installation. The iQ system interprets a full blockage as a vacuum spike within the ductwork, indicating that the extraction system is unable to maintain the set airflow due to the blockage.

During this time, it is normal to hear the blower increase in speed. The blockage will need to remain in the ductwork for over 5 seconds to trigger the alarm.

To remove the blockage, isolate the extraction system from the mains, remove the flexible hose, locate, and remove the blockage, then reattach the hose as previously installed.

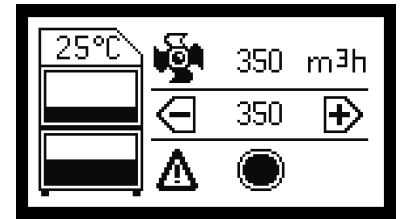

#### 7.1.4. Gas filter monitoring - VOC sensor (optional)

If the VOC sensor option has been fitted to your iQ system, then this will constantly monitor the exhaust gas of the extraction system.

If the VOC level in the exhaust exceeds the PPM (parts per million) level pre-set at Donaldson BOFA, the carbon within the filter is saturated and this will trigger the gas alarm and display the gas icon as shown.

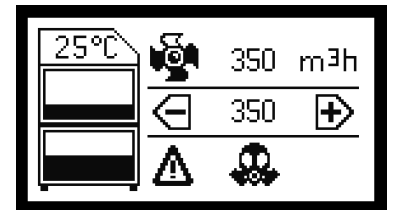

#### Removing the gas alarm warning

At this point, the the extraction system should be isolated from the mains, and a new combined filter fitted. Once a new filter is installed, the alarm will clear.

#### 7.1.5. Laser cooling filter blocked (optional)

For extraction systems fitted with the optional cooling blower, the symbol below will be displayed when the cooling blower filter becomes blocked.

1. Isolate the supply from the extraction system.
2. Undo the two latches on the front of the extraction system and open the door.
3. The cooling filter is recessed in the blower access panel, remove the filter from the frame.
4. Bag and seal the used filter, place new filter into frame.
5. Close door and fasten the two latches.
6. Reconnect the power supply to the extraction system.



#### 7.1.6. Door open alarm (optional)

If your system is configured with door open alarm, the extraction system will have been fitted with a micro switch to detect if the front door has been closed correctly. If the door has not been closed correctly, the symbol shown on the right will be displayed.



#### 7.1.7. Run safe feature

To ensure personnel protection and avoid damage to the extraction system, the iQ system will automatically shut down five seconds after no combined filter is detected. If no combined filter is fitted, the blower will stop and the display will appear as below.

To resolve this, isolate the extraction system, fit the combined filter, and turn the extraction system on.

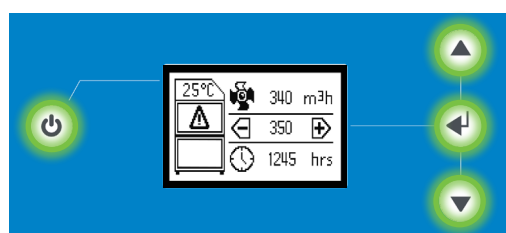

## 7.2. USB connectivity

The iQ system is equipped with a USB port that operates as a two-way device, as detailed below.

### Downloading iQ data

Customers can download all stored data within the iQ system, which can be used to keep records of system performance and diagnose issues with the extraction system.

To download iQ system settings:

1. Obtain a memory stick (maximum capacity 8 GB).
2. Place the iQ system in standby mode (front power button illuminating red).
3. Insert the memory stick into the USB port.
4. Press the button corresponding to download.
5. The display will show a progress bar, and when finished, a completion tick will appear.
6. The memory stick can now be removed from the extraction system, the door closed, and the system turned back on.

### Duplicating iQ data

This USB upload feature is intended for customers who have multiple extraction systems and a specific set of parameters that they want to replicate across their iQ extraction systems.

To duplicate iQ system settings:

1. Follow steps 1 to 6 from download iQ data section to obtain original settings from your master iQ system or obtain file from your seller.
2. Follow steps 2 to 3 from download procedure on duplicate system.
3. Press the button corresponding to upload.
4. Follow steps 5 to 6 from download procedure.

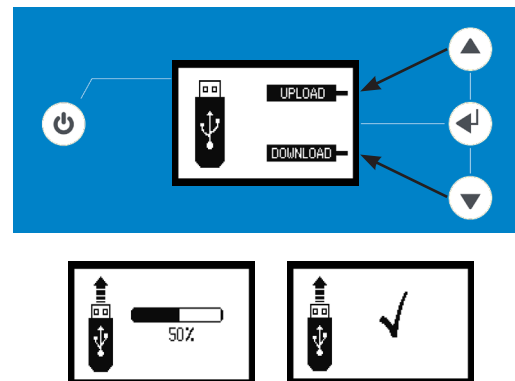
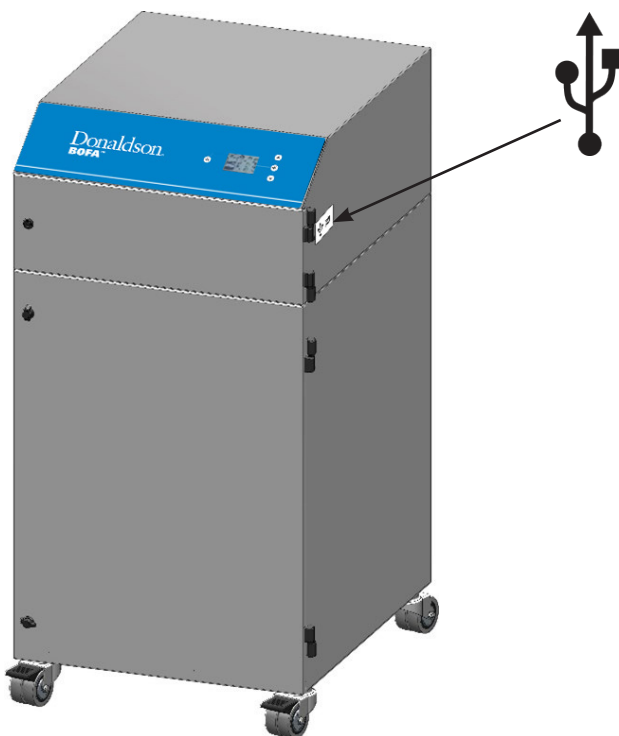

**WARNING**

If the USB upload procedure fails, the screen will display the symbol shown on the right.



### **7.2.1. Event log**

The iQ system will take a snapshot of the system performance every fifteen minutes, or if a system adjustment is made, or an alarm is triggered.

Some of the information captured is listed below:

#### **Date and time**

The date and time will be set as part of the testing stage with the manufacturer and set to GMT.

#### **Airflow**

Real-time airflow through the extraction system.

#### **Airflow set point**

Target flow rate that has been set by the user. This will record every time an adjustment is made.

#### **Pre-filter % blocked**

Pre-filter blockage is shown as an exact percentage of its full capacity.

#### **Combined filter % blocked**

Combined filter blockage is shown as an exact percentage of its full capacity.

#### **Inlet % (installation restriction)**

Percentage of the iQ system capacity that is taken up by the installation pipework. This value would also rise if the inlet or pipework becomes blocked.

#### **Blower output**

Percentage the blower is being run at to achieve the airflow set by the user. This value will increase as the filters begin to block.

#### **Internal temperature**

Internal temperature of the extraction system, the sensor is mounted to the main PCB when this sensor reaches 140 °F (60 °C) it will shut down the extraction system and a log will be recorded.

#### **Hours run**

Hours run counter that will begin from the first time the extraction is switched on by the user. The hours run counter will only be activated when the blower is running.

## Alarms

When the iQ system has an issue that requires the user to act upon, this is classed as an alarm. When this occurs, a code will appear. The main alarm codes are listed below.

Code	Meaning
1	Door open (optional)
4	VOC alarm
16	Over temperature
32	Inlet partially blocked
64	Inlet fully blocked
128	No combined filter fitted
512	Blower failure
2048	System 100% blocked
4096	Combined filter blocked
8192	Pre-filter blocked
524288	System 75% blocked

## Faults

This column will display a code if a fault with the iQ system is detected. For analysis of any faults in this column, please contact Donaldson BOFA technical service.

## 8 Troubleshooting

### 8.1. Fault indication

The iQ system intelligently monitors the whole extraction system. In the unlikely event of a problem with the extraction system, please read this section of the manual before contacting the helpline.

This section contains details on all faults the iQ system can display. These faults are detailed below.

#### 8.1.1. Blower failure detection

If the extraction system develops a fault relating to one of the blowers, then the blower icon on the display will stop rotating and flash, and the airflow will read 0 cfm (0 m<sup>3</sup>/h). For multi-blower systems, the alarm window will display the blower icon and indicate which blower has caused the failure (example on the right below).

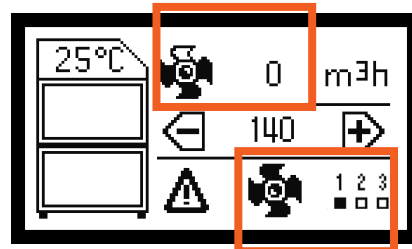
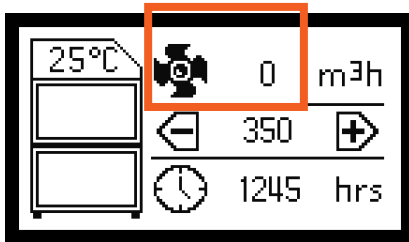

#### 8.1.2. Internal power supply

The extraction system is fitted with an internal transformer that outputs 12 VDC providing the iQ system with power.

If the buttons on the front panel are not illuminated or operational, this would indicate a problem with the internal power supply (provided the main isolation switch is in the on position and voltage is proven at this point).

If the internal power supply has failed, check whether your system is fitted with a 1 A in-line fuse, if so, this should be checked. If not the fuse, or fuse not included, arrangements should be made to replace the transformer.

#### 8.1.3. Error codes on the iQ display

The iQ system is able to self-diagnose problems relating directly to the monitoring system. Faults are displayed as a number in the error window within the display.

In the event of an error code being displayed, please contact your local representative or Donaldson BOFA who will be able to diagnose the fault and advise on the most efficient solution.

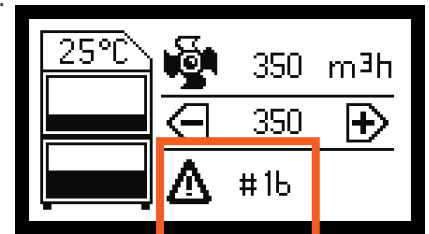

#### 8.1.4. USB diagnosis

For a “real-time” event log of any faults with your iQ system, please see section 7.2 to download a full analysis of the extraction system.

## 9 Replacement parts

### 9.1. Consumable spares

The extraction system contains a pre-filter and a combined filter. These should be replaced when instructed to do so by the iQ system (see maintenance section for replacing filters), when the extraction system is not performing efficiently, or at least once every 12 months.

To maintain performance, it is important that the filters are replaced with identical Donaldson BOFA filters. To reorder, please refer to the filter number printed on the filter installed in your extraction system. See part numbers below:

1. 1UA1030222 (pre-filter)
2. 1UA1030297 (combined filter)

### 9.2. Maintenance protocol

The iQ data logging function enables the retrieval of filter change intervals. Users may also wish to record changes in the table below.

Extraction System Serial Number:			
Pre-filter (1UA1030222)		Combined filter (1UA1030297)	
Date	Engineer	Date	Engineer

### 9.3. Filter disposal

The pre-filter and combined filter are manufactured from non-toxic materials. Filters are not reusable, cleaning used filters is not recommended. The method of disposal of the used filters depends on the material deposited on them.

For your guidance:

Deposit	EWC* Listing	Comment
Non-hazardous	15 02 03	Can be disposed of as non-hazardous waste.
Hazardous	15 02 02M	The type of hazard needs to be identified and the associated risks defined. The thresholds for these risks can then be compared with the amount of material in the filters to see if they fall into the hazardous category. If so, the filters will need to be disposed of in line with the local/national regulations.

\*European Waste Catalogue

## 10 System specifications

Extraction system: **AD 1000 iQ**

Flowrate minimum: 177 cfm (300 m<sup>3</sup>/h)

Flowrate maximum: 459 cfm (780 m<sup>3</sup>/h) @ 230 V,  
430 cfm (730 m<sup>3</sup>/h) @ 115 V

Weight: 324 lbs (147 kg)

Airflow measuring system: Windvane

Suction pressure: 60 mBar (+/- 3%) @ 230 V,  
65 mBar (+/- 5.7%) @ 115 V

Blower: Centrifugal fan

Output: 2 kW

Noise level: Below 70 dB(A) (at typical operating speed)

Maximum altitude – 2000 m

Electrical supply: 115 V/19.5 A, 230 V/12.5 A

Hertz: 50/60 Hz

No. of phases: 1

Indoor use only

Overvoltage category II

Pollution degree 2

Not for use in wet applications

Environmental operating range:

Temperature: +41 °F (5°C) to + 104 °F (40°C)

Humidity: Max 80% RH up to 87.8 °F (31°C)

Max 50% RH at 104 °F (40°C)

Process fume/gas entering this system should be within the above temperature range.

**Wiring schematic and spare parts list available upon request.**

Size:

	Imperial (inches)	Metric (mm)
Height	47.4	1205
Width	24.4	620
Depth	31.1	790

Filters:

Filter type	Surface area	Efficiency
Pre-filter	322.8 sq ft (30 m <sup>2</sup> )	F8 50% @ 0.3 microns
Combined filter	80.7 sq ft (7.5 m <sup>2</sup> )	99.995% @ 0.3 microns

Combined filter (gas section):

Filter type	Carbon type	Volume
Combined filter (gas)	Activated carbon	53.7 ltr

## 11 Contact information

### Donaldson BOFA head office – UK & ROW:

19-20 Balena Close

Tel. +44 (0) 1202 699 444

Creekmoor Industrial Estate

Email: [bofasales@donaldson.com](mailto:bofasales@donaldson.com)

Poole

Dorset

BH17 7DU

United Kingdom

---

### Donaldson BOFA German office:

Email: [bofavertrieb@donaldson.com](mailto:bofavertrieb@donaldson.com)

---

### Donaldson BOFA US office:

303 S Madison Street

Tel. +1 (618) 205 5007

Stanton, Illinois

Email: [bofasalesus@donaldson.com](mailto:bofasalesus@donaldson.com)

62088 USA

## 12 Inspection record



### Inspection Record

#### Local Exhaust Ventilation System

Health & Safety at Work Act 1974 - Control of Substances Hazardous to Health - Regulation 9 (2002) Thorough Examination and Testing of Local Exhaust Ventilation Systems

Company:	System Designation:	System Installation Date:
Designated Person:		

#### Inspection and Maintenance Schedules

1. Daily checks.
2. Weekly inspection of process enclosure, extract offtake, hose/ducting, and extraction system.
3. Monthly inspection of process enclosure, extract offtake, hose/ducting, and extraction system.
4. Yearly inspection/testing.

**Process enclosure, extract offtake(s), hose/ducting, and extraction system.**

**Inspection and Maintenance Record**

**1. Daily inspection**

Inspection of the process to ensure extract devices/nozzles/enclosures/hoses are in place and correctly positioned. Examination of the extraction system to ensure it is running. This to be carried out by the operator. Daily inspection not recorded.

**2. Weekly inspection**

Weekly inspection by supervisor of physical condition of extract devices/nozzles/enclosures/hoses and extraction system for damage, change (parts added or removed) and correct operation, etc. Check also that daily inspections have been completed. Tick boxes to confirm system ok/change. Add details of any changes.

Report changes to Engineering Manager. Record any remedial actions taken.

Week number	Date	System ok	System change	Details of change/repairs, etc.	Initial
1					
2					
3					
4					
5					
6					
7					
8					
9					
10					
11					
12					
13					
14					
15					
16					
17					
18					
19					
20					
21					
22					
23					
24					
25					

Weekly inspection by supervisor of physical condition of extract devices/nozzles/enclosures/hoses and extraction system for damage, change (parts added or removed) and correct operation, etc. Check also that daily inspections have been completed. Tick boxes to confirm system ok/change. Add details of any changes.

Report changes to Engineering Manager. Record any remedial actions taken.

Week number	Date	System ok	System change	Details of change/repairs, etc.	Initial
26					
27					
28					
29					
30					
31					
32					
33					
34					
35					
36					
37					
38					
39					
40					
41					
42					
43					
44					
45					
46					
47					
48					
49					
50					
51					
52					

**Process enclosure, extract offtake(s), hose/ducting, and extraction system.**

**Inspection and Maintenance Record**

**3. Monthly inspection**

In addition to weekly checks, disconnect hoses and check for blockage and smooth operation of fan, signs of dust or vapor/gas/odor carry over. Tick boxes to confirm system ok/change. Add details of any changes. Report changes to Engineering Manager. Record any remedial actions taken.

Week number	Date	System ok	System change	Details of change/repairs, etc.	Initial
1					
2					
3					
4					
5					
6					
7					
8					
9					
10					
11					
12					

**4. Yearly inspection**

	Comments	Supervisor signature:	Date:
Annual service to include all regular checks, inspection of filter condition, blower, and electrical system, and a filter replacement (if not changed within the previous 12 months).			
Annual thorough inspection and testing of LEV system in accordance with C.O.S.H.H. regulation 9 (max interval 14 months) including reporting.			