



A Donaldson Company

A WORLD LEADER IN FUME
EXTRACTION TECHNOLOGY

FireBOX GA

USER MANUAL



Contents

1	01	Overview of your FireBOX Unit (front)
	02	Overview of your FireBOX Unit (back)
2	01	Important safety notes
	02	Safety labels
3	01	Unpacking and unit placement
4	01	Fume capture methods
	02	Connecting to power supply
	03	Connecting ducting & sensor hose
5	01	Turning extraction unit on / Setting trip point
	02	Warning beacon & Valve testing
6	01	Cleaning the unit
	02	Pre-filter replacement
7	01	Consumable spares & filter disposal
8	01	FireBOX specifications & Shipping information

Overview

1 01

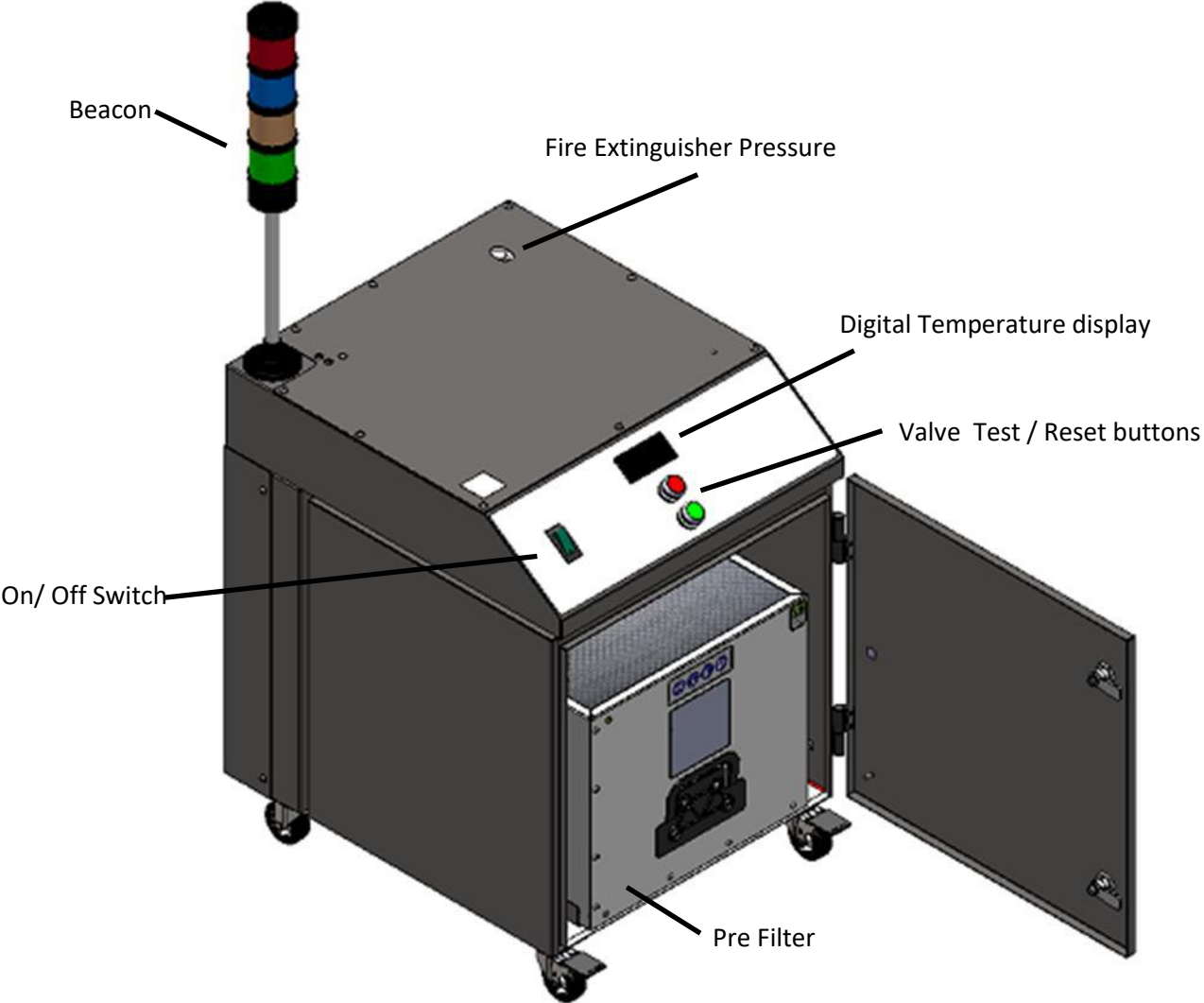

Overview

1 02

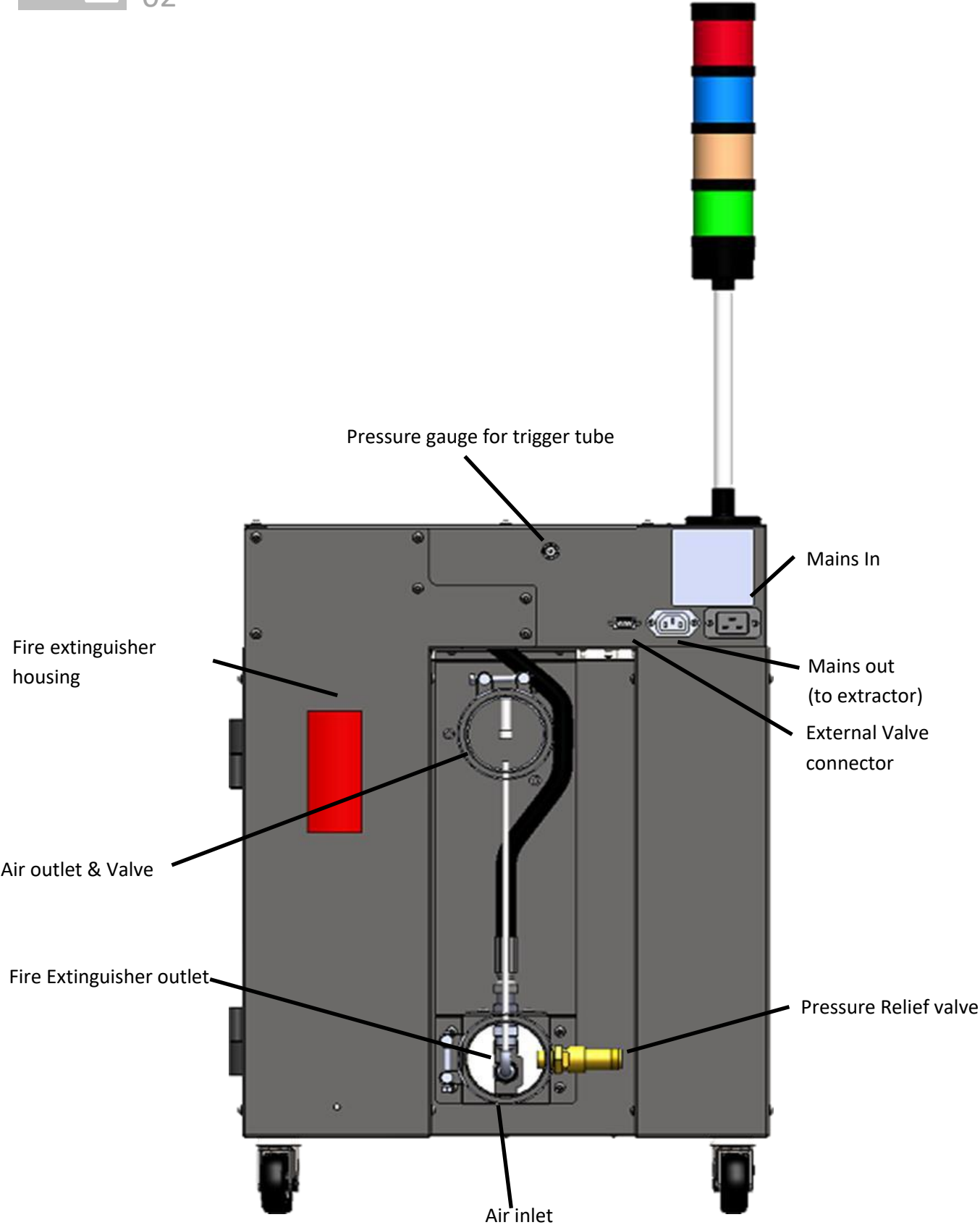

Safety Instructions



Important safety notes

Concerning symbols used on the extraction unit and referred to within this manual.



Danger

Refers to an immediately impending danger. If the danger is not avoided, it could result in death or severe (crippling) injury. Please consult the manual when this symbol is displayed.



Warning

Refers to a possibly dangerous situation. If not avoided it could result in death or severe injury. Please consult the manual when this symbol is displayed.



Caution

Refers to a possibly harmful situation. If not avoided, damage could be caused to the product or something in its environment.



Important (Refer to manual)

Refers to handling tip and other particularly useful information. This does not signify a dangerous or harmful situation. Refer to manual when this symbol is displayed.

Safety

The unit has been designed to meet the Essential Health and Safety Requirements of the Machinery Directive 2006/42/EC.

Warning

When working with the pump/motor housing open, Live 230/115 volt mains components are accessible. Ensure that the rules and regulations for work on live components are always observed.

Important

To reduce the risk of fire, electric shock or injury:

1. Always isolate the system from the mains power supply before removing the electrical access panel.
2. Use only as described in this manual.
3. Connect the system to a properly grounded outlet.

Dangers to eyes, breathing and skin

Once used, the filters within the FireBOX may contain a mixture of particulates, some of which may be sub-micron size. When the used filters are moved it may agitate some of this particulate, which could get into the breathing zone and eyes of the operative. Additionally, depending on the materials being lasered, the particulate may be an irritant to the skin.

Caution: When changing used filters always wear a mask, safety shoes, goggles and gloves.

BOFA Technical Service

If a problem arises with your FireBOX, please:

- Visit our website at www.bofainternational.com for on-line help.
- Or contact the helpline on **+44 (0) 1202 699 444**, Mon-Fri, 9am-5pm.
Email: Technical@bofa.co.uk

Serial Number

For future reference, fill in your unit details in the space provided. The serial number is on the rating label located on the side/rear of the unit.

Serial Number:

□□/□□-FIREBOX-□□□

Serial Number (Fire extinguisher)

□□□□□□□□□□□□□□

Safety Instructions



Warning and Information labels

The following listing details labels used on your unit.

Goggles, Gloves & Mask Label



Meaning: Goggles, Gloves and Masks should be worn while handling used filters.

Electrical Danger



Meaning: Removal of panels with this label attached will allow access to potentially live components.

Warning Label



Meaning: Power should be isolated before the panel with this label attached is opened/ removed.

Caution Hot



Meaning: Surfaces of the unit may be hot. Take care when handling the unit.

Serial Number Label



*example of label

Meaning: This label contains a variety of information about the extraction unit, including.

- Company name, Address & Contact number
- Extractor model
- Unit serial number
- Operating voltage range
- Maximum current load
- Operating frequency
- Year of Manufacture
- Relevant approval markings/ logos

PLEASE NOTE: If the equipment is used in a manner not specified by the manufacturer, the protection provided by the equipment maybe compromised.

Fire Risk Warning

In the very rare event that a burning ember or spark is drawn into the unit, it may be possible that the filters will ignite.

Whilst any resultant fire would typically be retained within the unit, the damage to the unit could be significant. It is therefore essential to minimise the possibility of this occurring by undertaking an appropriate Risk assessment to determine:-

- a). Whether additional fire protection equipment should be installed.
- b). Appropriate maintenance procedures to prevent the risk of build-up of debris which could potentially combust.

This unit should not be used on processes where sparks could occur, with explosive dusts and gases, or with particulates which can be pyrophoric (can spontaneously ignite), without implementation of additional precautions

It is essential that nozzles or other extraction/ fume capture devices and hoses/pipework are cleaned regularly to prevent the build-up of potentially ignitable debris

Before installation

3 01

Unit placement

Before installation, check the unit for damage. All packaging must be removed before the unit is connected to the power supply.

Please read all instructions in this manual before using this extractor.

1. Move the unit to the location where it is going to be installed and remove the outer packaging. **This unit should be installed in a well-ventilated area.**
2. Open the front door and check the filter is located correctly. (remove any transit foam, if fitted)

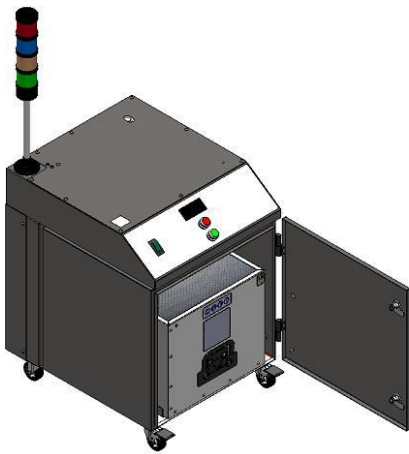

Caution

Due to the weight of the extractor suitable lifting equipment should be used and with regard to appropriate safety precautions. (See Appendix for product weight details)

Ensure that 500 mm space is available around any vented panels on the unit to ensure adequate airflow.

3. With the unit in position lock the 2 front castors.

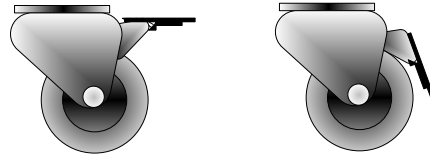

Unlocked Position

Locked Position

Caution

 Do not block or cover any cooling vents on the unit, as this severely restricts airflow and may cause damage to the unit.

Caution

 Under no circumstances should the exhaust outlet/s be covered as this will restrict the airflow and cause overheating.

4. Check the filters are located in their correct position before closing the door and securing the door latches.

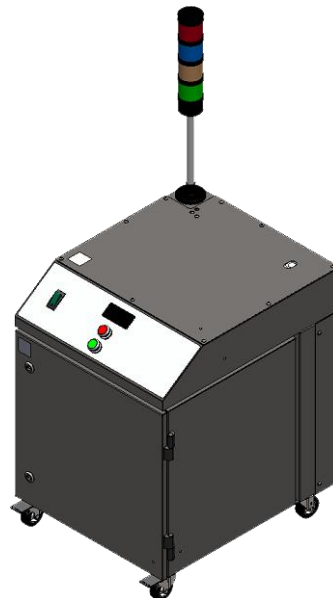

Installation

4 01

The unit has been designed to be installed as an inline device that should be connected between the fume source and the extraction unit for non-metallic applications. Please contact BOFA if unsure if your application is correct for this product.

BOFA recommends that a 2nd suitable fire extinguisher is kept nearby the product.

Requirement: Metal pipework must be used.

Fume Capture Methods

The fume is normally captured by 1 of 3 methods.

- Flexible arm/ Nozzle
- Enclosures
- Cabinets

General Guidelines for a successful installation

- Keep duct run length to a minimum
- Avoid sharp bends / turns in the ductwork
- Avoid multiple bends / turns in the ductwork
- Use a larger diameter duct where able
- Position the capture device as close as possible to the marking point. (if used on high speed lines, position the capture device slightly downstream)

Flexible Arm & Nozzle Extraction

The stay put arm should be mounted as close as possible to the marking point using the horseshoe clips. Remove the connector from the other side of the flexible hose. Cut the flexible hose to suit the distance back to the extractor connection and connect onto the extractor inlet.

Purge air should be kept to a minimum, where possible, to prevent the fume being blown away from the nozzle.

High speed lines may need bigger scoops or nozzles both sides of the bottles because of the turbulence caused by the speed of the line.

Moving products

For applications where the product to be marked is moving past the stationary head the capture nozzle should be positioned as close as possible to the marking area on the side the product is moving towards.

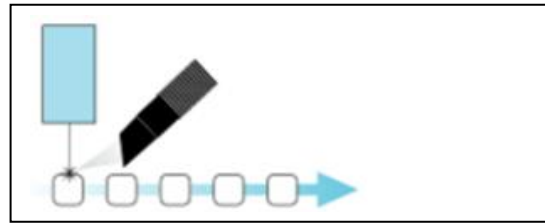

to the
that the
point.

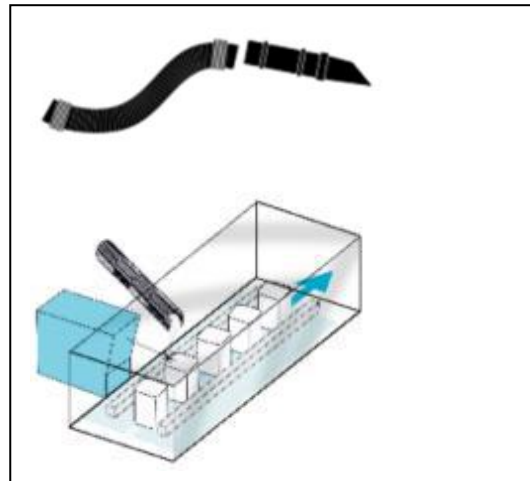

Cabinets

Cabinets normally have a 75mm or 100mm spigot for fume extraction. For best performance use the same diameter hose as the spigot and reduce at the extractor end if necessary. **Keep the hose run as short as possible.**

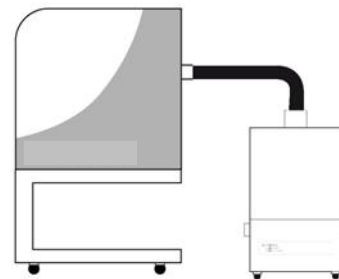

Connection to extraction unit

All ductwork should be installed and connected to the extraction unit before the system is turned on.

Installation

4₀₂

Connecting Auxiliary extraction unit

The FireBOX should be paired with a BOFA Fume extraction unit (up to a capacity of 500m³/h)

The power supply for the extractor should be connected through the FireBOX to ensure the airflow is stopped when the FireBOX detects an issue. (Max 13A)

The mains cable from the extractor unit should be wired with the IEC plug provided and connected to the IEC outlet below.

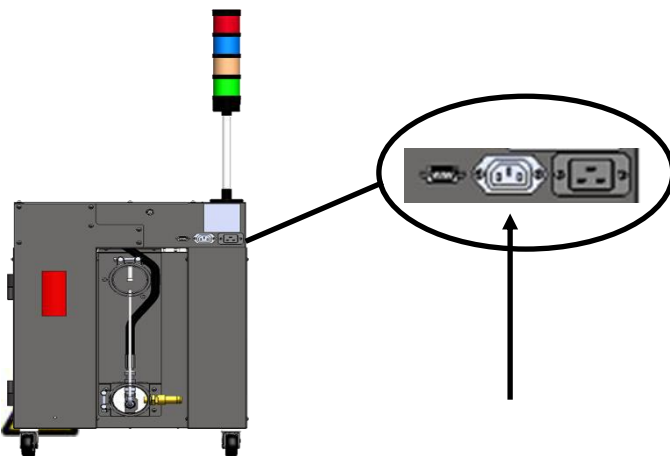

Isolate the mains supply when connecting power leads

Connection to Power Supply

Please follow the specification at the end of this manual when selecting the power supply outlet. Consideration must also be given to the electrical load that will be connected to the FireBOX from the extraction unit., ensure the power supply is suitable before connecting the FireBOX.

Check the Integrity of the electrical power cable, if the supply cord is damaged the extraction unit should not be connected to the mains. A PAT test is required after the mains cable is changed.

The system **MUST** be connected to a properly earthed outlet.

Connect the power cable to an isolated electrical supply.

The mains socket should be installed near the FireBOX and should be easily accessible and able to be switched On/ Off. The cable run should be arranged so as not to create a trip hazard.

Installation

4 03

Connecting the Vacuum sensor hose

If the FireBOX is going to be connected to a BOFA Autoflow extraction unit then an additional sensor tube **MUST** be connected. The sensor tube should be run from the outlet of the FireBOX to the inlet of the extractor. (run inside the flexible hose)





The following procedure must be carried out with the electrical supply isolated.

- 1: Attach and secure the sensor tube to the small standpipe located inside the extractor inlet.
- 2: Run the sensor tube through the flexible hose and cut to length.
- 3: On the FireBOX there may be a black rubber cover over the small sensor standpipe. (on the firebox inlet) this **must** be removed.(see picture below)
- 4: Attach and secure other end of sensor tube to the FireBOX outlet.

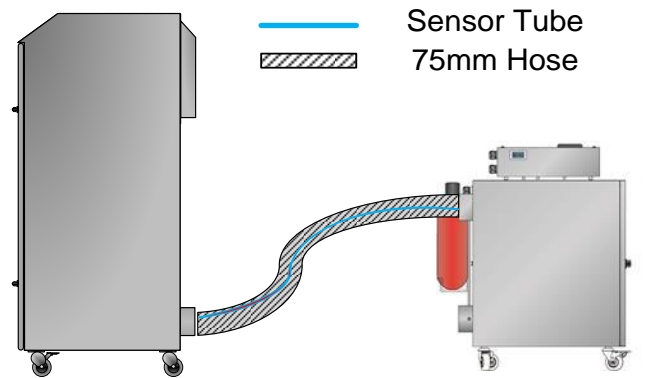
The connectors should be attached to the standpipe inside the 75mm port on the FireBOX with the sensor tube attached. The sensor tube should then be run inside the 75mm hose and connected at the other end to the BOFA extraction unit.

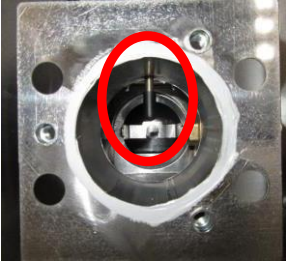

FireBOX	BOFA Extractor
	
	

Operation



Turning FireBOX On

ENSURE THE AMBIENT TEMPERATURE IS BELOW 30 DEGREES CELSIUS BEFORE SWITCHING THE FIREBOX ON FOR THE FIRST TIME.

To switch the FireBOX "On" the (I) side of the switch should be depressed. (Refer to section 1 for switch location)
To turn it off the (O) side should be depressed.

Please Note: Turning the FireBOX off will disconnect the power to any auxiliary unit connected through the FireBOX.

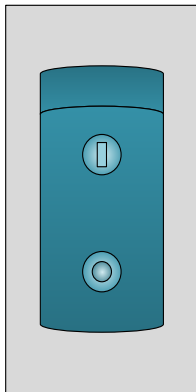

Stainless Steel Unit

The extractor and all pipe work must be fully installed and connected before the Unit is turned ON.

Setting the controller

The controller is factory set at 30°C but it is very important that the controller is adjusted 10°C higher than the airflow temperature when running in normal conditions.

When the controller reaches the set temperature the power to the extractor will be stopped!

Setting the temperature too low, will cause the power to be

cut prematurely.

Setting the temperature to high, will not cut the power at the correct time.

It is the customers responsibility to set the correct temperature set point.

How to set the controller

Take an ambient temperature measurement in the area where the FireBOX will be located.

1. Press the "P" button and the screen will display "SP" as shown below.



2. The controller is now in set mode. Use the Up / Down button to set the temperature .

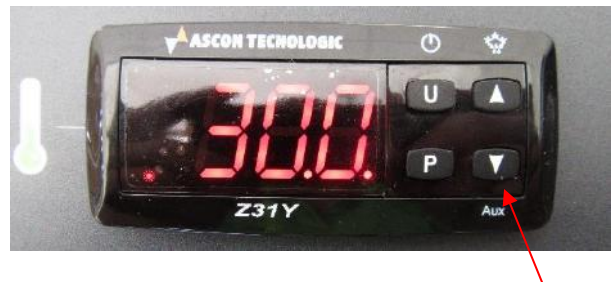

3. Press the "P" button once again; this will save the new trip point.

Operation



Warning Beacon

The FireBOX includes a 4-colour beacon. This is used to provide the operator with a clear indication on the status of the FireBOX.

The diagram below provides information on each colour.



- RED – Fire extinguisher deployed
- BLUE – Valves moving (opening/closing)
- ORANGE – Over temperature
- GREEN - OK

Green light – Unit is operational and running within the temperature parameters.

Blue light – This will activate when the airflow valves are operating. They will also appear when the test valve buttons are used on the front of the FireBOX.

Orange light – Unit has detected a temperature above your setpoint. (set at 10 degrees above ambient by the operator) While in this status the valves will be closed and the power to the extraction unit will be Off.

Red Light – FireBOX has detected another temperature rise beyond the orange light status (another 10 degrees) at this point the fire extinguisher will be activated.

Valve testing

The Green and Red buttons on the front of the FireBOX can be used to test and reset the valves.

Red button (Test valves)

Pressing this button will close the valves. Press and hold the button for 1 second to activate the test.

Green Button (Reset Valves)

Pressing this button will open the valves. Press and hold for 1 second and check the Valves are in the open position before operation.

In the event of initial 10 degrees rise (orange light)

The firebox will have stopped the line. At this time it is important to follow your risk assessment procedure. If the extraction system has been inspected and is safe to use then cycle the power and press the green button to open the valves and continue operation. If not then the FireBOX should be taken out of use and replaced.

In the event of the Fire extinguisher deployment

The FireBOX has been designed to suppress any fire within the unit by stopping airflow and closing the valves to limit the supply of oxygen. If the fire continues then the on-board fire extinguisher will be deployed. Although this action should extinguish the fire BOFA recommends that at this time the hoses and electrical connections are quickly removed from the FireBOX and the FireBOX is moved to a safe location outdoors.

At this time some parts of the FireBOX may be hot so suitable precautions must be taken to avoid harm.

Maintenance



Maintenance UK

It is a legal requirement, under regulation 9 of the COSHH regulations that all local exhaust ventilation systems are thoroughly examined and tested at least once every 14 months (typically carried out annually). The approved code of practice recommends that a visual check should be carried out at least once a week.

COSHH requires the annual inspection and testing to be carried out by a competent person and specifies that documentation results are recorded in a log.

Contact the seller for more information about inspection and certification.

Maintenance General

User maintenance is limited to cleaning the unit and filter replacement, only the manufacturers trained maintenance technicians are authorised to carry out component testing and replacement. Unauthorised work or the use of unauthorised replacement filters may result in a potentially dangerous situation and/or damage to the extractor unit and will invalidate the manufacturer's warranty.

Extinguisher Maintenance

It is recommended that the Fire extinguisher included with this product is included into your weekly extinguisher inspection regime and that this extinguisher is added to your fire extinguisher annual servicing.

All fire equipment must be suitably maintained by a competent person in line with your countries legal requirements. If you are in any doubt please consult with your safety department or local authority.

Cleaning the unit

The stainless steel units should be cleaned with a proprietary stainless steel cleaner, in accordance with the manufacturer's user instructions

Replacing Filters

The BOFA extraction system that is connected to the FireBOX will constantly monitor the condition of the system filters. As the filters block the extraction unit will display this (see extraction unit user manual for details) When the alarm is given by the extraction unit the filter in the FireBOX should be changed first.

A log of the changes should be maintained by the user. The filters require attention when the display shows the filter blocked icon/ filter output signal (if fitted) or when the extractor no longer removes fume efficiently.

It is recommended that a spare set of filters are kept on site to avoid prolonged unit unavailability. Part numbers for replacement filters can be found on the filters fitted in your system. Alternatively, refer to the spare parts table in this manual.

To prevent overheating, units should not be run with a blocked filter condition, or with dust obstruction of Inlets / Outlets.

Maintenance

6₀₂

Pre Filter Replacement

The Pre filter needs replacing when the extraction unit alerts the user to do so and if fitted the filter blocked signal will be given. (Refer to extraction unit user manual for specification)

To remove and replace the Pre filter follow the procedure detailed below.

1. Isolate the electrical supply to the FireBOX
2. Undo the catch on the front of the unit and open the door.
3. The Pre filter is located inside, using the handle on the front of the filter; pull it out of the unit.
4. Once removed it is recommend that the used filters are bagged and sealed.
5. Slide the new filter into position making sure it is pushed all the way in and is located correctly on the spigot in the back of the unit.
6. Close the door and fasten the 2 latches.

If the extraction unit filter blocked alarm is still present after the FireBOX filter has been changed then the filters in the extraction unit should be changed (refer to extraction unit manual)

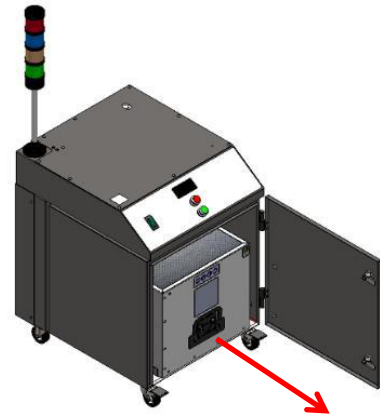

Replacement Parts



Consumable Spares

The FireBOX contains a pre filter that should be replaced when instructed to do so by the BOFA extraction system (see section 6 for replacing the filters) or when the fume is no longer being efficiently removed.

To maintain performance it is important that the filters are replaced with identical BOFA filters. To re-order please refer to the table below.

Maintenance Protocol

Filter changes may be recorded in the table below.

Unit Serial Number:	
Pre filter	
Date	Engineer

Filter disposal

The filters are manufactured from non-toxic materials. Filters are not re-usable, cleaning used filters is not recommended. The method of disposal of the used filters depends on the material deposited on them.

For your guidance

Deposit	EWC Listing*	Comment
Non Hazardous	15 02 03	Can be disposed of as non-hazardous waste.
Hazardous	15 02 02M	The type of hazard needs to be identified and the associated risks defined. The thresholds for these risks can then be compared with the amount of material in the filters to see if they fall into the hazardous category, if so, the filters will need to be disposed of in line with the local/national regulations.

*European Waste Catalogue

System Specifications & Shipping Information



Unit: FireBOX

Max Capacity: 500m³/h (294cfm)

Weight: 56Kg (123Lbs)

Electrical supply: 115-230V

Hertz: 50/60Hz

Full Load Current: 13A

Size:

	Metric (mm)	Imperial (inches)
Height / With Beacon	679 / 1192	26.73 / 46.92
Depth	575	22.64
Width	501	19.72

Filters:

Filter Type	Surface area	Efficiency
Pre filter	12.0m ²	95% @ 0.9micron

Environmental operating range:

Temperature: +5°C to + 40°C

Humidity: Max 80% RH up to 31°C

Max 50% RH at 40°C

Shipping Instructions – Dangerous Goods Classification

The Firebox product category contains components which means that it has been classified as a Dangerous good under the Dangerous Goods Regulations.

The classification of the product falls under UN1044 - FIRE EXTINGUISHERS, CLASS 2.2 and will need addressing for transport via both Air and Sea. On the occasion that the product is to be moved via road freight then it is exempt from ADR Regulations for transport (Under Special Provision 594) and no further action is required.

For more information, please contact BOFA or your freight forwarder.

Contact Information

BOFA Headquarters

19-20 Balena Close
Creekmoor industrial Estate
Poole
Dorset
BH17 7DU
UK
Phone: +44 (0) 1202 699444

BOFA Americas

303 S.Madison Street
Staunton
Illinois
62088
USA
Phone: 001 (618) 205 5007

BOFA International GmbH

Sudring 62
D-21465
Wentorf bei Hamburg
Germany
Phone: +49 (0) 40 7393735-15