



A WORLD LEADER IN FUME
EXTRACTION TECHNOLOGY

AD Base 1 Oracle

Last Updated on 01.02.2022



A 'two in one' solution that runs on any voltage worldwide and doubles up as a workstation by placing the laser engraver on top.

The Advantage Base 1 Oracle has been designed so that a number of manufacturers' laser engravers can sit on top of the extractor, effectively doubling it up as a workstation. All the Base units in the range have the option of an onboard compressor for a compact installation. BOFA's 'easi-seal' filter location makes filter change easy, quick and safe.

The revolutionary auto-voltage sensing turbine automatically self adjusts to run on any voltage worldwide, while the reverse flow filter technology enhances filter performance and ensures longer filter life.

Automatic flow control allows the user to preset correct flow rates, giving lower noise levels and further protection of both the combined filter and the patented DeepPleat DUO pre-filter.

Technology



DeepPleat DUO pre-filter



HEPA filter



Automatic flow control (AFC) technology



Reverse flow air (RFA) technology



Advanced carbon filter (ACF) technology



Multi voltage sensing (MVS) unit



Patented technology



ProTECT service plan



SureCHECK quality standard

Key features of the AD Base Oracle 1

Auto sensing voltage (100-230v) for global use
Standard

DeepPleat DUO pre-filter
Standard

Automatic flow control
Standard

Advanced carbon filter technology
Standard

Contact BOFA at <https://bofainternational.com/en/contact/>
<https://bofainternational.com/en/portal/datasheets/ad-base-1-oracle/>



Approvals: REACH and RoHS. See individual product technical data for specific accreditations

HEPA and gas combined filter
Standard

'Easi-seal' filter location
Standard

Low noise level
Standard

On-board compressor
Optional

Filter change / system fail signal
Optional

Reverse flow
Standard

Small footprint
Standard

VOC gas sensor (Volatile Organic Compound)
Optional





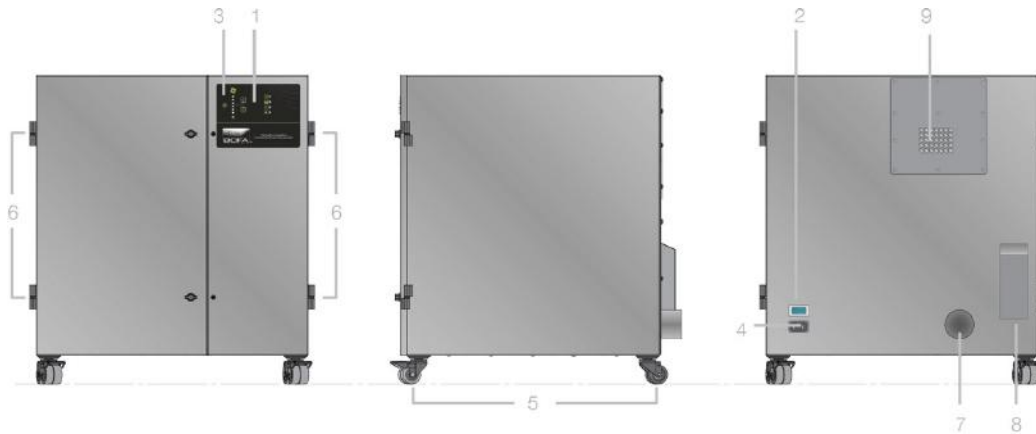

Remote stop / start interface
Optional

Technical specification

- 1. Unit / filter condition display - automatic flow control
- 2. On / off switch
- 3. Standby button
- 4. Power cable inlet
- 5. Castors
- 6. Door hinge
- 7. Hose inlet connection - 75mm
- 8. Exhaust outlet
- 9. Motor cooling inlet



Airflow through filters

-  Chemical filter
-  HEPA filter
-  Pre-filter
-  Clean air
-  Contaminated air
-  Particulate

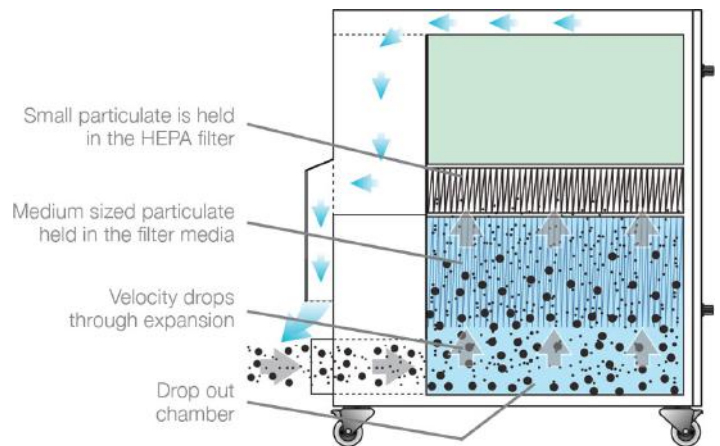

Technical data

90-257V

Technical data

Dimensions (HxWxD)	790 x 735 x 740mm (31.10 x 28.94 x 29.13")
Cabinet construction	Powder coated mild steel
Airflow / pressure	380m ³ /hr / 96mbar (223cfm / 96mbar)
Electrical data	100-230v single-phase 1~ 50/60Hz Full load current: 12.5 amps / 1.1kw
Noise level	< 64dBA (at typical operating speed)
Weight	86kg (189lbs)
Approvals	UKCA and CE

DeepPleat DUO pre-filter specifications

Surface media area	12m ² approx (129.12 ft ²)
Filter media	Borosilicate
Filter media construction	Pleated with glue bead spacers
Filter housing	Zintec mild steel
Filter efficiency	95% @ 0.9 microns
Inlet size	75mm (0.24ft)
Dropout chamber size	16.2 litres
Filter media pleat size	200mm (0.65 ft)

Combined filter specifications

HEPA filter media	Borosilicate
HEPA media construction	Maxi pleat construction with glue bead spacers
Filter housing	Zintec mild steel
Treated activated carbon	15kgs (33 lbs)
Filter efficiency	99.997% @ 0.3 microns

Part numbers

Model	Voltage	Part no.	24V stop / start	Filter change / system failure signal	VOC monitoring
AD Base 1 Oracle powder coated	90V - 257V	L5144	A2001	A2002	A2003
AD Base 1 Oracle with compressor, powder coated	230V	L5142	A2001	A2002	A2003

Replacement filters

Model	DeepPleat DUO pre-filter	Combined filter
AD Base 1 Oracle	A1030156	A1030155

Other languages

AD Base 1 Oracle
[Japanese](#)

AD Base 1 Oracle
[French](#)

Datasheet correct at time of publishing.

Where applicable, the carbon used in BOFA units is capable of removing a wide range of VOCs, however it is the responsibility of the user to ensure the carbon is suitable for their application. For specific applications, please contact us for details.

Important Notice: *Many factors beyond the control of BOFA can affect the use and performance of BOFA products in a particular application, including the conditions under which the product is used. Since these factors are uniquely within the user's knowledge and control, it is essential the user evaluate the products to determine whether the product is fit for the particular purpose and suitable for the user's application. All products, product specifications, availability and data are subject to change without notice, and may vary by region or country.*

Think before you print! Please consider the environment before printing this document.

